

Versione per CAP. 1 - CAP. 10 - IP 54
Execution for CAP. 1 - CAP. 10 - IP 54

Versione per CAP. 3 - IP 65
Execution for CAP. 3 - IP 65

Tensione massima	48 Vca/cc	Max. voltage	48 Vac/dc
Intensità di corrente resistiva	0.5 (0.2) A	Current	0.5 (0.2) A
Campo di temperatura	-40°C...+140°C (in funzione della membrana/guarnizione)	Temperature range	-40°C to +140°C (according to diaphragm/seal material)
Max. n° di interventi a 25°C	200/1' (membrana)	Max. cycle rate at 25°C	200/min. (diaphragm type)
Max. n° di interventi a 25°C	80/1' (pistone)	Max. cycle rate at 25°C	80/min. (piston type)
Protezione fast-on	IP 00	Protection (terminals)	IP 00
Protezione con CAP. 1 - CAP. 10	IP 54	Protection with CAP. 1 - CAP. 10	IP 54
Protezione con CAP. 3	IP 65	Protection with CAP. 3	IP 65
Corpo portacontatti	PA 66	Switch housing	PA 66
Vita meccanica	10 ⁶ cicli	Mechanical life	10 ⁶ operations
Prova di rigidità	1500 V - 10 mA - 10"	Strength test	1500 V - 10 mA - 10"
Coppia di serraggio consigliata	Max. 4 Kgm vedi pagina 3	Recommended tightening torque	Max. 4 Kgm see page 3

CAPPUCCI DI PROTEZIONE / PROTECTION CAPS

PROTEZIONE IP 54 / IP 54 PROTECTION

COD. 31060
Tipo
Type **CAP. 1**

Cavo $\varnothing 4.1$ min.
Cable $\varnothing 4.1$ min.

55

$\varnothing 33$

Compatibile per entrambe le versioni
Suitable for both executions

COD. 31013
Tipo
Type **CAP. 10**

Cavi $\varnothing 1.5 + \varnothing 2.9$
Cables $\varnothing 1.5 + \varnothing 2.9$

19

$\varnothing 33$

Compatibile per entrambe le versioni
Suitable for both executions

PROTEZIONE IP 65 / IP 65 PROTECTION

COD. 31015
Tipo
Type **CAP. 3**

Vite di fissaggio
Fastening screw

40

$\varnothing 30$

31

PG 7

Compatibile solo con opzione "CAP. 3"
Suitable for "CAP. 3" execution only

SIGLA DI ORDINAZIONE / HOW TO ORDER

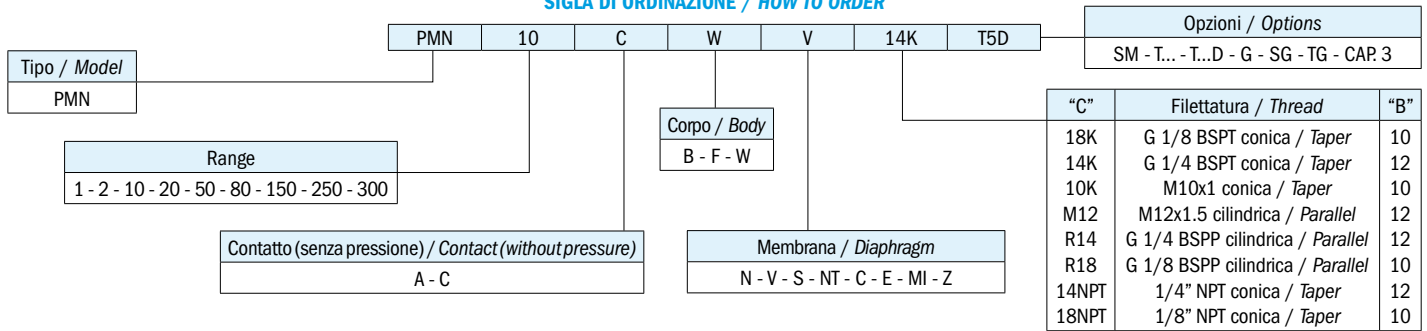

SPIEGAZIONE DELLE SIGLE DI ORDINAZIONE / ORDERING INFORMATION

PMN...	Pressostato con connessione a fast-on 6.3x0.8
Tipo di contatto	A NA normalmente aperto C NC normalmente chiuso
Materiale corpo Ch 24 (vedi caratteristiche generali)	B Ottone F Acciaio zincato W AISI 316 a richiesta su tutti i modelli
Membrana disponibile/guarnizione	N NBR (-5°C...+60°C) V FKM (-5°C...+90°C) S Silicone (-30°C...+120°C) NT HNBR (-25°C...+140°C) C Neoprene (-10°C...+90°C) E EPDM (-20°C...+110°C) MI Acciaio Inox (-30°C...+140°C) solo su PMN 1-2-10 Z ZNBR (-40°C...+60°C)
Filettature disponibili	18K G 1/8 BSPT conica 14K G 1/4 BSPT conica 10K M10x1 conica M12 M12x1.5 cilindrica R14 G 1/4 BSPP cilindrica R18 G 1/8 BSPP cilindrica 14NPT 1/4" NPT conica 18NPT 1/8" NPT conica
Opzioni	SM Smorzatore per colpi d'ariete T... Taratura in salita al valore richiesto (es. T2 taratura in salita a 2 bar) T...D Taratura in discesa al valore richiesto (es. T5D taratura in discesa a 5 bar) G Contatti dorati per bassa corrente SG Sgrassati per utilizzo con ossigeno TG Testati per utilizzo con gas CAP.3 Versione per utilizzo del CAP.3

PMN...	Pressure switch with push-on terminals 6.3x0.8
Contact type	A NO normally open C NC normally closed
24 AF body material (see general specifications)	B Brass F Zinc plated steel W S.s. 316 on request for all models
Available diaphragm/seal	N NBR (-5°C to +60°C) V FKM (-5°C to +90°C) S Silicone (-30°C to +120°C) NT HNBR (-25°C to +140°C) C Neoprene (-10°C to +90°C) E EPDM (-20°C to +110°C) MI Stainless steel (-30°C to +140°C) only PMN 1-2-10 Z ZNBR (-40°C to +60°C)
Available threads	18K G 1/8 BSPT taper 14K G 1/4 BSPT taper 10K M10x1 taper M12 M12x1.5 parallel R14 G 1/4 BSPP parallel R18 G 1/8 BSPP parallel 14NPT 1/4" NPT taper 18NPT 1/8" NPT taper
Options	SM Snubber for pressure picks T... Set-point rising to the required value (ex. T2 rising set-point adjustment at 2 bar) T...D Set-point falling to the required value (ex. T5D falling set-point adjustment at 5 bar) G Gold-plated contact for low current SG Degreased for applications with oxygen TG Tested for applications with gas CAP.3 Execution suitable for CAP.3

CARATTERISTICHE GENERALI / GENERAL SPECIFICATIONS

TIPO MODEL	CAMPO DI LAVORO PRESSIONI RELATIVE ADJUSTMENT RELATIVE PRESSURE RANGE bar	DIMENSIONI "A" DIMENSIONS "A" mm		MAX. PRESSIONE STATICA SUPPORTABILE MAX. STATIC PRESSURE bar			DIFFERENZIALE FISSO MAX. 25°C MAX. FIXED HYSTERESIS AT 25°C bar	TOLLERANZA D'INTERVENTO 25°C TOLERANCE AT 25°C bar	ESECUZIONE EXECUTION
		VERSIONE PER CAP. 1 VERSION FOR CAP. 1	VERSIONE PER CAP. 3 VERSION FOR CAP. 3	ESEC. CORPO OTTONE BRASS BODY EXECUTION	ESEC. CORPO ACCIAIO ZINCATO ZINC PLATED BODY EXECUTION	ESEC. CORPO ACCIAIO INOX AISI 316 S.S. 316 BODY EXECUTION			
PMN 1	0.1 - 1	40	46	300	300	300	0.1	±0.1	Membrana Diaphragm
PMN 2	0.15 - 2	40	46	300	300	300	0.15	±0.2	
PMN 10	2 - 10	40	46	300	300	300	0.2	±0.3	
PMN 20	10 - 20	40	46	300	300	300	0.3	±0.4	
PMN 50	20 - 50	40	46	300	300	300	0.8	±1	
PMN 80	50 - 80	40	46	300	300	300	5.5	±2	
PMN 150	50 - 150	43	49	600	600	600	10	±5	Pistone in acciaio Steel piston
PMN 250	100 - 250	43	49	600	600	600	15	±10	
PMN 300	50 - 300	43	49	600	600	600	20	±15	

Elettrotec si riserva la facoltà di apportare modifiche tecniche ai prodotti o di cessarne la produzione senza obbligo di preavviso. Il contatto del pressostato può danneggiarsi quando sottoposto a forti urti o ad alte vibrazioni. È responsabilità dell'utilizzatore verificare l'idoneità dei nostri prodotti per ogni particolare applicazione (ad esempio, la verifica della compatibilità dei materiali) e l'uso può essere appropriato solo se dimostrato in test sul campo. Le informazioni tecniche in questo catalogo si basano su prove effettuate durante lo sviluppo del prodotto e in base ai valori empiricamente raccolti. Essi non possono essere applicabili in tutti i casi.

Elettrotec reserves the right to technical data of change to the products or halt production without prior notice. The pressure switch contacts can be damaged when subject to strong shocks or high vibration. It is the responsibility of the user to test the suitability of our products for the particular application, for example, the verification of material compatibility. The use may only be appropriate if proven in field tests. The technical information in this catalogue are based on tests made during product development and based on empirically gathered values. They may not be applicable in all cases.

DATI TECNICI GENERALI GENERAL TECHNICAL DATA

PRESSOSTATO A MEMBRANA, CONTATTO NC
DIAPHRAGM PRESSURE SWITCH, NC CONTACT

SENZA PRESSIONE
WITHOUT PRESSURE

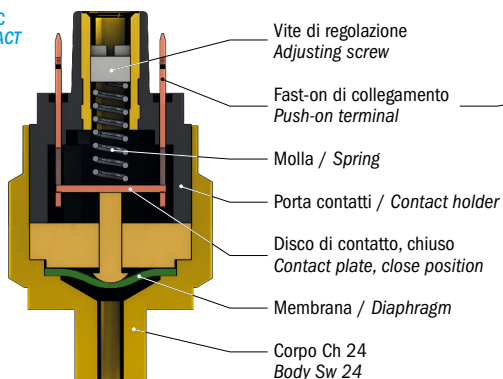

CON PRESSIONE
WITH PRESSURE



PRESSOSTATO A MEMBRANA, CONTATTO NA
DIAPHRAGM PRESSURE SWITCH, NO CONTACT

SENZA PRESSIONE
WITHOUT PRESSURE

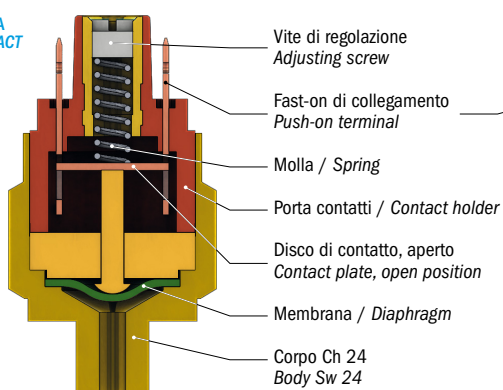

CON PRESSIONE
WITH PRESSURE

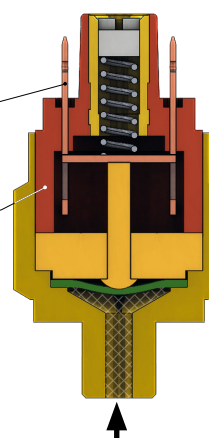

COPIE DI SERRAGGIO CONSIGLIATE / RECOMMENDED TIGHTENING TORQUES

Ottone / Brass		Acciaio zincato Zinc plated steel		AISI 316 / S.s. 316	
Filetto Thread	Coppia di serraggio* Recommended tightening torque Nm	Filetto Thread	Coppia di serraggio* Recommended tightening torque Nm	Filetto Thread	Coppia di serraggio* Recommended tightening torque Nm
R18	17	R18	22	R18	24
18K	17	18K	22	18K	24
18NPT	17	18NPT	22	18NPT	24
5/8UNF	30	5/8UNF	40	5/8UNF	45
R12	40	R12	55	R12	60
R14	25	R14	35	R14	40
14K	25	14K	35	14K	40
14NPT	25	14NPT	35	14NPT	40
M10	18	M10	25	M10	30
M12	23	M12	32	M12	35
10K	18	10K	25	10K	30
34K	50	34K	70	34K	80

TIPOLOGIA DI CONTATTI ELETTRICI UTILIZZATI / ELECTRICAL CONTACTS APPLIED













Contatti / Contacts			Normativa DIN-EN-60947-5-1 Standard DIN-EN-60947-5-1	Simbolo IEC 60617 Symbol IEC 60617
NA	NA normalmente aperto NO normally open	SPST (single pole, single throw)	X	
NC	NC normalmente chiuso NC normally closed	SPST (single pole, single throw)	Y	
SC	SC contatti in scambio CO change over (snap action)	SPDT (single pole, double throw)	C	

* Una scorretta coppia di serraggio può influenzare la durata della macchina del pressostato. Variando tipologia di materiale utilizzato per realizzare il corpo del pressostato, varierà anche la coppia di serraggio.

* Improper torque may affect the mechanical life of the switch. The relevant legislation has been expressed in various ways. By varying the type of material used to make the switch body, will also vary the tightening torque.

PRESSOSTATI / PRESSURE SWITCHES

PROTEZIONI ELETTRICHE ELECTRIC PROTECTIONS

Pagina / Page		PMN	PMM	PM250	MS	PS	PSM PSP	PMC PMC...D	PPC PPCF	PPC...D PPCF...D	PML	PPL	PSK	MPS	PHP	PHC		
Protezione IP 54 <i>IP 54 electric protection</i>		9	11	13	15	15	17...24	25	27	27	29	29	31	33	35	37		
Protezione IP 54 <i>IP 54 electric protection</i> CAP. 1  CAP. 10  CAP. 12  CAP. 16  CAP. 30  CAP. 31 		●	●	●												●		
		●	●														●	
								●										
						●	●								●			
																		●
																		●
Protezione IP 65 <i>IP 65 electric protection</i> CAP. 3  CAP. 13  Connettore DIN 40050 <i>DIN 40050 connector</i> 		●	●	●													●	
						●	●											
								●	●	●	●	●	●	●	●			
Protezione IP 67 <i>IP 67 electric protection</i> CAP. 14 + cavi + connettore <i>CAP. 14 + flying leads + connector</i>  Connettore M12 / M12 connector  Deutsch DT04-2P integrato 		●		●	●	●											●	
						●	●	●	●	●	●	●	●	●	●			
																●		
DATI ELETTRICI <i>ELECTRIC DATA</i>		PMN	PMM	PM250	MS	PS	PSM PSP	PMC PMC...D	PPC PPCF	PPC...D PPCF...D	PML	PPL	PSK	MPS	PHP	PHC		
Tensione di alimentazione / Power supply	12 Vca/cc	●	●	●	●	●	●	●	●	●	●	●	●	●	●	●	●	
	24 Vca/cc	●	●	●	●	●	●	●	●	●	●	●	●	●	●	●	●	
	48 Vca/cc	●	●	●	●	●	●	●	●	●	●	●	●	●	●	●	●	
	110 Vca/cc			●	●	●	●	●	●	●	●	●	●	●	●	●	●	
	220 Vca/cc			●	●	●	●	●	●	●	●	●	●	●	●	●	●	
	250 Vca/cc			●	●	●	●	●	●	●	●	●	●	●	●	●	●	
Corrente massima / Max. current	< 30 mA	●	●	●	●	●	●	●	●	●	●	●	●	●	●	●	●	
	0.5 A	●	●	●												●		
	3 A							●	●	●	●	●	●				●	
	4 A																●	
	6 A					●	●	●									●	
	7 A													●			●	
	8 A																●	
	10 A							●	●	●	●	●	●	●				●
15 A																	●	
Contatti argentati / Silver plated contacts		●	●	●	●	●	●	●	●	●	●	●	●	●	●	●	●	
Contatti dorati / Gold plated contacts		●	●	●	●	●	●	●	●	●	●	●	●	●	●	●	●	
Isteresi fissa / Fixed hysteresis		●	●	●	●	●	●	●	●	●	●	●	●	●	●	●	●	
Isteresi regolabile / Adjustable hysteresis							●											
Corpo Ch 24 / Body 24 AF		●	●	●	●	●					●	●		●	●			
Corpo Ch 27 / Body 27 AF							●											

Elettrotec si riserva la facoltà di apportare modifiche tecniche ai prodotti o di cessarne la produzione senza obbligo di preavviso. Il contatto del pressostato può danneggiarsi quando sottoposto a forti urti o ad alte vibrazioni. È responsabilità dell'utilizzatore verificare l'idoneità dei nostri prodotti per ogni particolare applicazione (ad esempio, la verifica della compatibilità dei materiali) e l'uso può essere appropriato solo se dimostrato in test sul campo. Le informazioni tecniche in questo catalogo si basano su prove effettuate durante lo sviluppo del prodotto e in base ai valori empiricamente raccolti. Essi non possono essere applicabili in tutti i casi.

Elettrotec reserves the right to technical data of change to the products or halt production without prior notice. The pressure switch contacts can be damaged when subject to strong shocks or high vibration. It is the responsibility of the user to test the suitability of our products for the particular application, for example, the verification of material compatibility. The use may only be appropriate if proven in field tests. The technical information in this catalogue are based on tests made during product development and based on empirically gathered values. They may not be applicable in all cases.