

Tensione massima	250 Vca	Max. voltage	250 Vac
Intensità di corrente	6 (2) A	Current	6 (2) A
Contatti elettrici	SPDT	Electrical contacts	SPDT
Differenziale regolabile	10% ÷ 30% del valore di taratura	Adjustable hysteresis	10% - 30% of set-point
Campo di temperatura	-25°C...+140°C (in funzione della membrana/guarnizione)	Temperature range	-25°C to +140°C (according to diaphragm/seal material)
Num. max. interventi a 25°C	120/1' (membrana)	Max. cycle rate at 25°C	120/min. (diaphragm type)
Num. max. interventi a 25°C	60/1' (pistone)	Max. cycle rate at 25°C	60/min. (piston type)
Protezione	IP 65 DIN 40050 vedi pagina 8	Protection	IP 65 DIN 40050 see page 8
Connettore PG09 o PG11	DIN 43650	PG09 or PG11 connector	DIN 43650
Vita meccanica	10 ⁶ cicli	Mechanical life	10 ⁶ operations
Coppia di serraggio consigliata	Max. 5 Kgm. vedi pagina 3	Recommended tightening torque	Max. 5 Kgm. see page 3

CONNESSIONI ELETTRICHE DISPONIBILI / AVAILABLE ELECTRICAL CONNECTIONS

PROTEZIONE IP 65 / IP 65 PROTECTION

Connettore DIN 40050
DIN 40050 connector

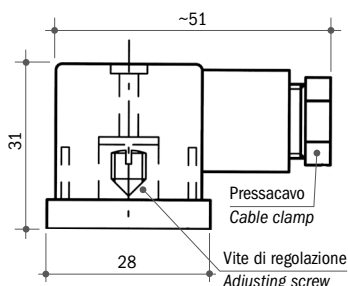

Connettore trasparente con Led bicolore rosso/verde
Transparent connector with red/green bi-coloured led

Tipo
Type **CLB**

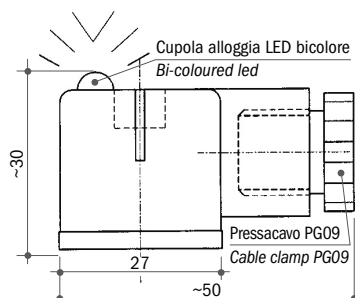

Connettore M12
M12 connector

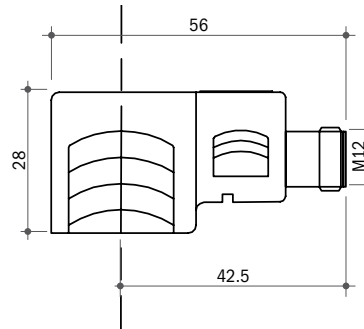

SIGLA DI ORDINAZIONE / HOW TO ORDER

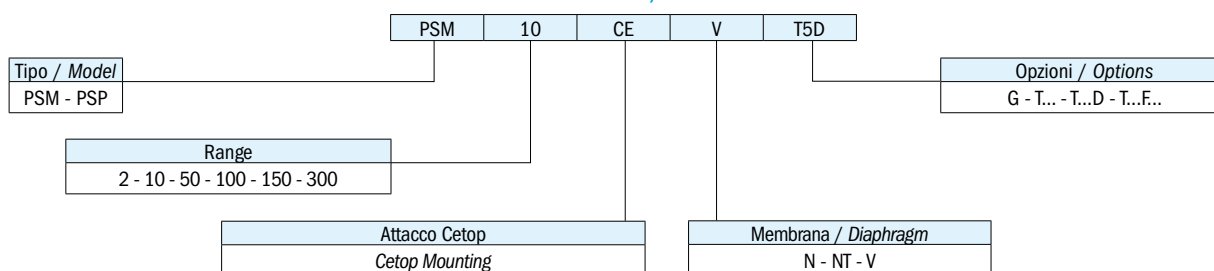

SPIEGAZIONE DELLE SIGLE DI ORDINAZIONE / ORDERING INFORMATION

PSM...CE	Pressostato a membrana per montaggio a piastra		
PSP...CE	Pressostato a pistone per montaggio a piastra		
Membrana disponibile/ guarnizione	N	NBR (standard)	(-5°C...+90°C)
	NT	HNBR	(-25°C...+140°C)
	V	FKM	(-5°C...+90°C)
	Opzioni		
G	Contatti dorati per bassa corrente		
T...	Taratura in salita al valore richiesto (es. T2 taratura in salita a 2 bar)		
T...D	Taratura in discesa al valore richiesto (es. T5D taratura in discesa a 5 bar)		
T...F...	Taratura del pressostato e del differenziale min. > 10% max. 30% del valore di taratura		

IN CONFORMITÀ ALLA DIRETTIVA 2014/30/CE.

PSM...CE	Diaphragm pressure switch for manifold mounting		
PSP...CE	Piston pressure switch for manifold mounting		
Available diaphragm/ seal	N	NBR (standard)	(-5°C to +90°C)
	NT	HNBR	(-25°C to +140°C)
	V	FKM	(-5°C to +90°C)
	Options		
G	Gold-plated contacts for low current		
T...	Set-point rising to the required value (ex. T2 rising set-point adjustment at 2 bar)		
T...D	Set-point falling to the required value (ex. T5D falling set-point adjustment at 5 bar)		
T...F...	Set-point and hysteresis at the required value if > 10% max. 30% of set-point		

IN COMPLIANCE WITH DIRECTIVE 2014/30/CE.

CARATTERISTICHE GENERALI / GENERAL SPECIFICATIONS

TIPO MODEL	CAMPO DI LAVORO PRESSIONI RELATIVE ADJUSTMENT RELATIVE PRESSURE RANGE bar	DIMENSIONI DIMENSIONS mm				MAX. PRESSIONE STATICA SUPPORTABILE MAX. STATIC PRESSURE bar	MATERIALE CORPO BODY MATERIAL	TOLLERANZA D'INTERVENTO 25°C TOLERANCE AT 25°C bar	ESECUZIONE EXECUTION
		A	B	C	D				
PSM 2 CE	0.2 - 2	80	35	45	40	300	Acciaio zincato Zinc plated steel	±0.2	Membrana Diaphragm
PSM 10 CE	1 - 10	80	35	45	40			±0.4	
PSM 50 CE	10 - 50	80	35	45	40			±2	
PSM 100 CE	10 - 100	80	35	45	40			±3	
PSP 150 CE	30 - 150	86	41	45	40	600		±5	Pistone in acciaio Steel piston
PSP 300 CE	50 - 300	86	41	45	40			±15	

Elettrotec si riserva la facoltà di apportare modifiche tecniche ai prodotti o di cessarne la produzione senza obbligo di preavviso. Il contatto del pressostato può danneggiarsi quando sottoposto a forti urti o ad alte vibrazioni. È responsabilità dell'utilizzatore verificare l'idoneità dei nostri prodotti per ogni particolare applicazione (ad esempio, la verifica della compatibilità dei materiali) e l'uso può essere appropriato solo se dimostrato in test sul campo. Le informazioni tecniche in questo catalogo si basano su prove effettuate durante lo sviluppo del prodotto e in base ai valori empiricamente raccolti. Essi non possono essere applicabili in tutti i casi.

Elettrotec reserves the right to technical data of change to the products or halt production without prior notice. The pressure switch contacts can be damaged when subject to strong shocks or high vibration. It is the responsibility of the user to test the suitability of our products for the particular application, for example, the verification of material compatibility. The use may only be appropriate if proven in field tests. The technical information in this catalogue are based on tests made during product development and based on empirically gathered values. They may not be applicable in all cases.

DATI TECNICI GENERALI GENERAL TECHNICAL DATA

PRESSOSTATO A MEMBRANA, CONTATTO NC
DIAPHRAGM PRESSURE SWITCH, NC CONTACT

SENZA PRESSIONE
WITHOUT PRESSURE



CON PRESSIONE
WITH PRESSURE



PRESSOSTATO A MEMBRANA, CONTATTO NA
DIAPHRAGM PRESSURE SWITCH, NO CONTACT

SENZA PRESSIONE
WITHOUT PRESSURE



CON PRESSIONE
WITH PRESSURE



COPIE DI SERRAGGIO CONSIGLIATE / RECOMMENDED TIGHTENING TORQUES

Ottone / Brass		Acciaio zincato Zinc plated steel		AISI 316 / S.s. 316	
Filetto Thread	Coppia di serraggio* Recommended tightening torque Nm	Filetto Thread	Coppia di serraggio* Recommended tightening torque Nm	Filetto Thread	Coppia di serraggio* Recommended tightening torque Nm
R18	17	R18	22	R18	24
18K	17	18K	22	18K	24
18NPT	17	18NPT	22	18NPT	24
5/8UNF	30	5/8UNF	40	5/8UNF	45
R12	40	R12	55	R12	60
R14	25	R14	35	R14	40
14K	25	14K	35	14K	40
14NPT	25	14NPT	35	14NPT	40
M10	18	M10	25	M10	30
M12	23	M12	32	M12	35
10K	18	10K	25	10K	30
34K	50	34K	70	34K	80

TIPOLOGIA DI CONTATTI ELETTRICI UTILIZZATI / ELECTRICAL CONTACTS APPLIED













Contatti / Contacts			Normativa DIN-EN-60947-5-1 Standard DIN-EN-60947-5-1	Simbolo IEC 60617 Symbol IEC 60617
NA	NA normalmente aperto NO normally open	SPST (single pole, single throw)	X	
NC	NC normalmente chiuso NC normally closed	SPST (single pole, single throw)	Y	
SC	SC contatti in scambio CO change over (snap action)	SPDT (single pole, double throw)	C	

* Una scorretta coppia di serraggio può influenzare la durata della macchina del pressostato. Variando tipologia di materiale utilizzato per realizzare il corpo del pressostato, varierà anche la coppia di serraggio.

* Improper torque may affect the mechanical life of the switch. The relevant legislation has been expressed in various ways. By varying the type of material used to make the switch body, will also vary the tightening torque.

PRESSOSTATI / PRESSURE SWITCHES

PROTEZIONI ELETTRICHE ELECTRIC PROTECTIONS

Pagina / Page		PMN	PMM	PM250	MS	PS	PSM PSP	PMC PMC...D	PPC PPCF	PPC...D PPCF...D	PML	PPL	PSK	MPS	PHP	PHC		
Protezione IP 54 <i>IP 54 electric protection</i>		9	11	13	15	15	17...24	25	27	27	29	29	31	33	35	37		
Protezione IP 54 <i>IP 54 electric protection</i> CAP. 1  CAP. 10  CAP. 12  CAP. 16  CAP. 30  CAP. 31 		●	●	●												●		
		●	●														●	
								●										
						●	●								●			
																		●
																		●
Protezione IP 65 <i>IP 65 electric protection</i> CAP. 3  CAP. 13  Connettore DIN 40050 <i>DIN 40050 connector</i> 		●	●	●													●	
						●	●											
								●	●	●	●	●	●	●	●			
Protezione IP 67 <i>IP 67 electric protection</i> CAP. 14 + cavi + connettore <i>CAP. 14 + flying leads + connector</i>  Connettore M12 / M12 connector  Deutsch DT04-2P integrato 		●		●	●	●											●	
						●	●	●	●	●	●	●	●	●	●			
																●		
DATI ELETTRICI <i>ELECTRIC DATA</i>		PMN	PMM	PM250	MS	PS	PSM PSP	PMC PMC...D	PPC PPCF	PPC...D PPCF...D	PML	PPL	PSK	MPS	PHP	PHC		
Tensione di alimentazione / Power supply	12 Vca/cc	●	●	●	●	●	●	●	●	●	●	●	●	●	●	●	●	
	24 Vca/cc	●	●	●	●	●	●	●	●	●	●	●	●	●	●	●	●	
	48 Vca/cc	●	●	●	●	●	●	●	●	●	●	●	●	●	●	●	●	
	110 Vca/cc			●	●	●	●	●	●	●	●	●	●	●	●	●	●	
	220 Vca/cc			●	●	●	●	●	●	●	●	●	●	●	●	●	●	
	250 Vca/cc			●	●	●	●	●	●	●	●	●	●	●	●	●	●	
Corrente massima / Max. current	< 30 mA	●	●	●	●	●	●	●	●	●	●	●	●	●				
	0.5 A	●	●	●							●	●	●	●		●		
	3 A							●	●	●	●	●	●				●	
	4 A																●	
	6 A					●	●	●									●	
	7 A													●			●	
	8 A																●	
	10 A							●	●	●	●	●	●	●			●	
15 A																●		
Contatti argentati / Silver plated contacts		●	●	●	●	●	●	●	●	●	●	●	●	●	●	●	●	
Contatti dorati / Gold plated contacts		●	●	●	●	●	●	●	●	●	●	●	●	●	●	●	●	
Isteresi fissa / Fixed hysteresis		●	●	●	●	●	●	●	●	●	●	●	●	●	●	●	●	
Isteresi regolabile / Adjustable hysteresis							●											
Corpo Ch 24 / Body 24 AF		●	●	●	●	●					●	●		●	●			
Corpo Ch 27 / Body 27 AF							●											

Elettrotec si riserva la facoltà di apportare modifiche tecniche ai prodotti o di cessarne la produzione senza obbligo di preavviso. Il contatto del pressostato può danneggiarsi quando sottoposto a forti urti o ad alte vibrazioni. È responsabilità dell'utilizzatore verificare l'idoneità dei nostri prodotti per ogni particolare applicazione (ad esempio, la verifica della compatibilità dei materiali) e l'uso può essere appropriato solo se dimostrato in test sul campo. Le informazioni tecniche in questo catalogo si basano su prove effettuate durante lo sviluppo del prodotto e in base ai valori empiricamente raccolti. Essi non possono essere applicabili in tutti i casi.

Elettrotec reserves the right to technical data of change to the products or halt production without prior notice. The pressure switch contacts can be damaged when subject to strong shocks or high vibration. It is the responsibility of the user to test the suitability of our products for the particular application, for example, the verification of material compatibility. The use may only be appropriate if proven in field tests. The technical information in this catalogue are based on tests made during product development and based on empirically gathered values. They may not be applicable in all cases.